

# Watermarks: from early trademark to modern security feature

Wendy Buckle

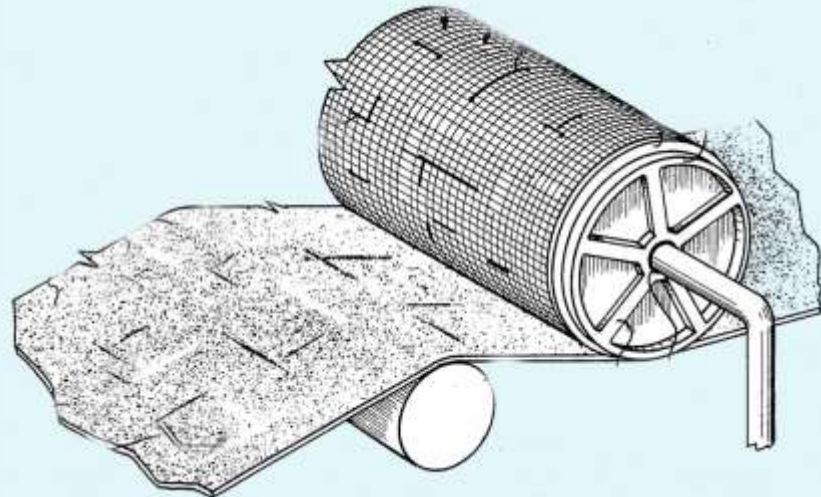

# Plan

- The invention of paper
- Handmade paper
- Early watermarks
- Machine-made paper
- Watermarks as security device
- Watermarks on stamps and postal stationery

# Paper was invented in China



Cai Lun, who first recorded the process

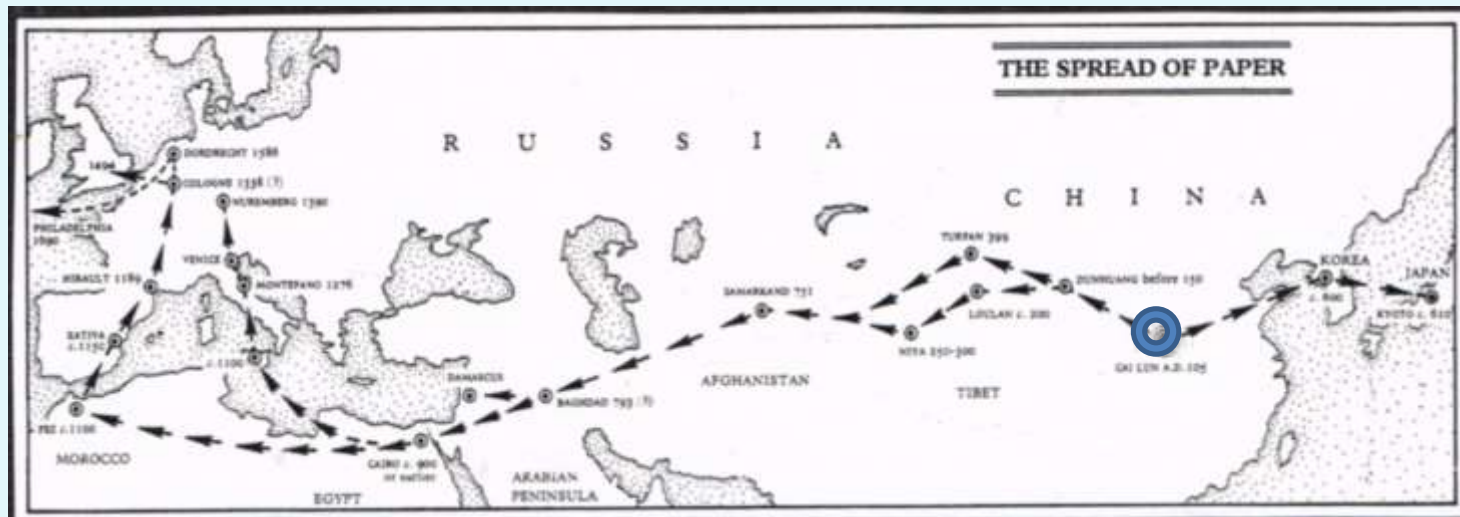

# The first watermarks: Fabriano, Italy



Official mail 12 September 1809

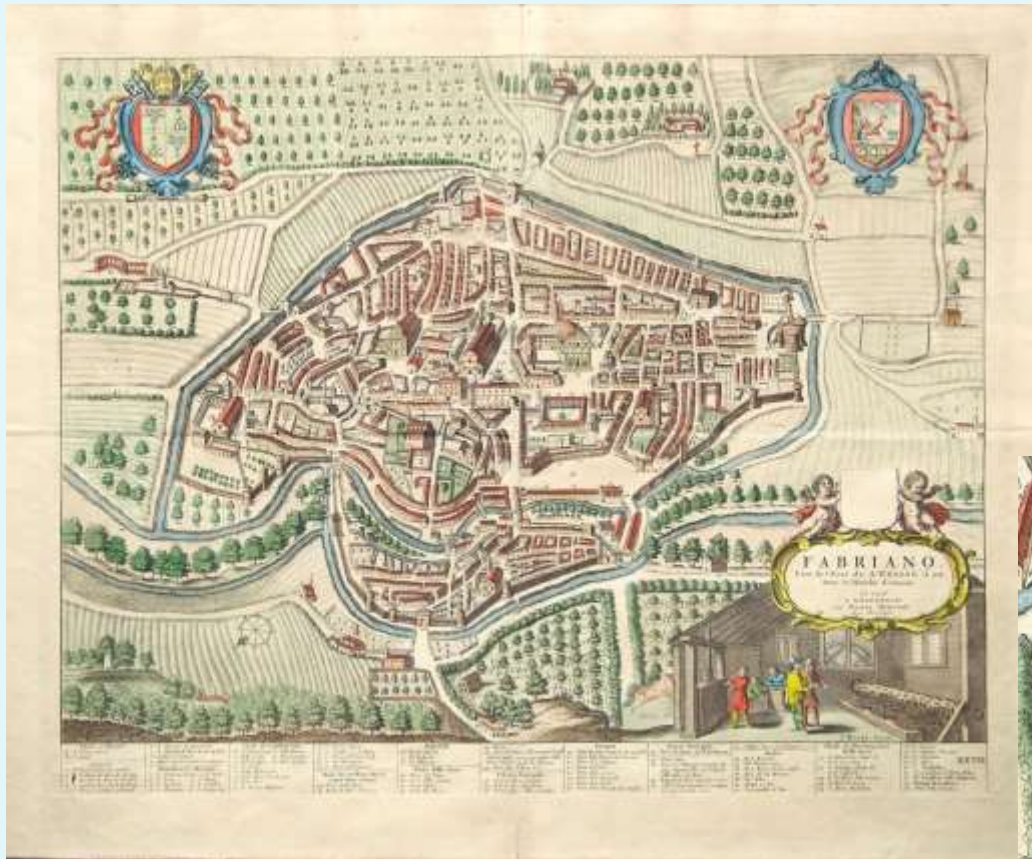

From: *Novum Italiae Theatrum* by Joan Blau, 1724



# Made the same way East and West



# The Mould



# The Mould and Watermark

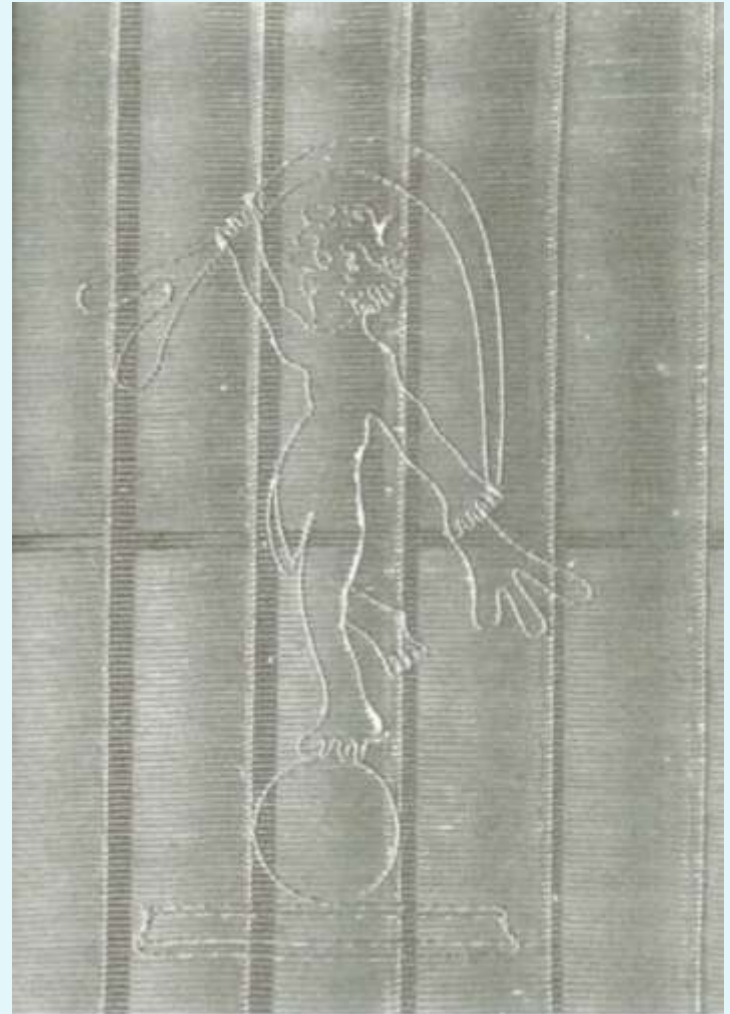
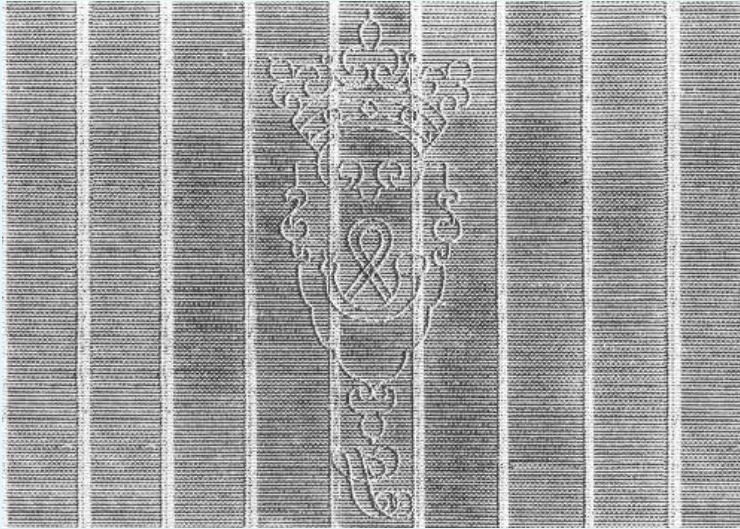

# Early and later use

- Trademark;
- Identification:
  - of matching pairs of moulds
  - of size of mould and therefore size of paper produced;
- Excise purposes.



Foolscap



Britannia



Pot



# Watermark designs: handmade paper



Thomasböle Mill, 1672



Polish official church mail with cardinal's blind seal for Andreas Bathory. c. 1595

# Machine-made paper

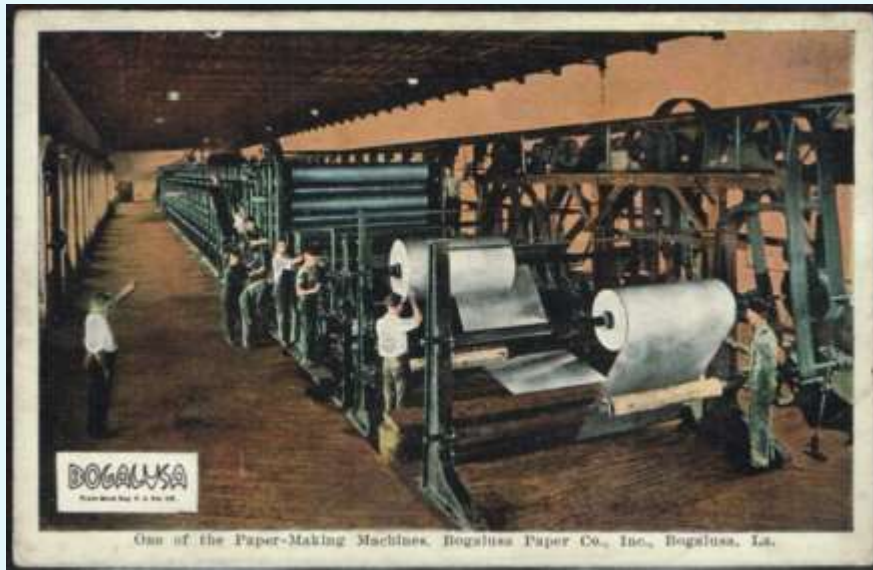
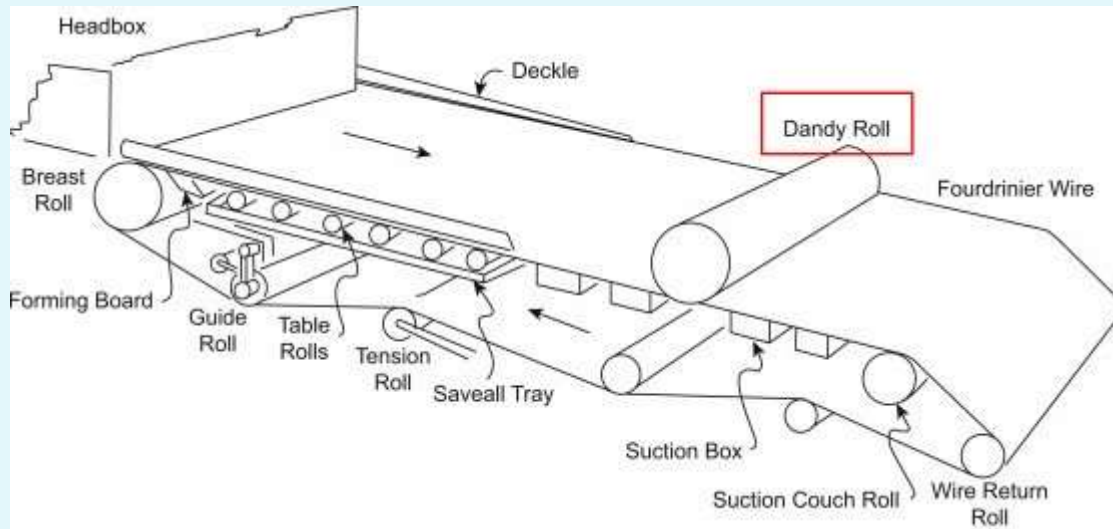

# Machine-made paper



# The Dandy Roll

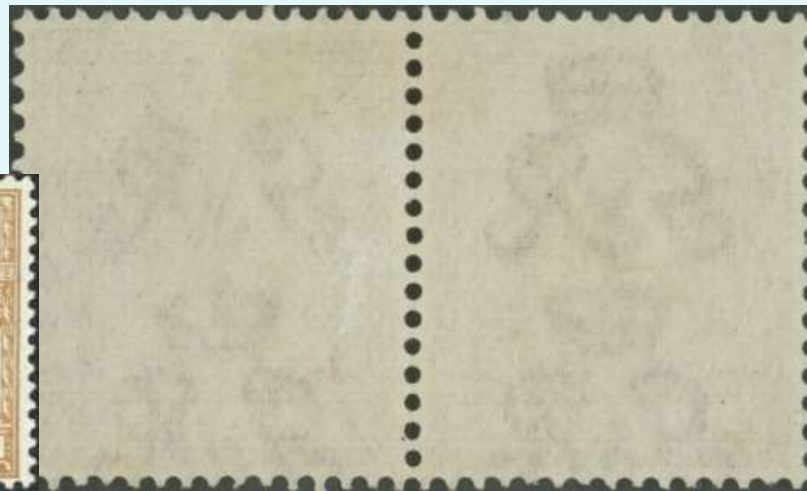
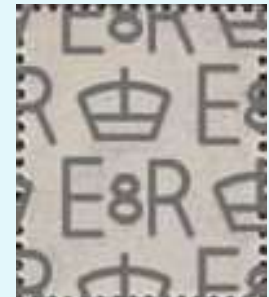
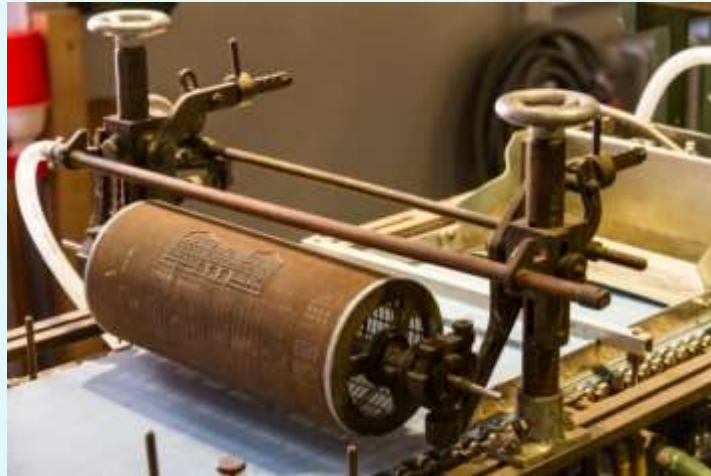

# Watermark designs: machine-made paper



Rheinische Papiermanufaktur  
Hermann Krebs AG, Mannheim.  
1856 - 1945



Julius Glatz Papier-Fabriken.  
Neidenfels. 1885 - present

# Watermark as security device





Revenue label for the excise duty on paper 1821



Sir William Congreve 1772 - 1828

# Security watermarks used on stamps

- Single: each stamp has a single design 
- Multiple: a single design repeated all over the sheet 
- Large sheet or All-over: a single design or pattern applied once or twice on a sheet of paper. The complete design will encompass multiple stamps, but many stamps in the sheet will have no watermark.

*Harrison & Son  
London. Harrison*



USA 1898 Tobacco Revenue

# Crowns



Crown CA



Imperial Crown



Hungary 1898



Italy 1863



Romania 1931





# Flora and fauna



GB Spray of  
Rose 1867



Linden leaf  
Czechoslovakia 1923



Laurel garland  
Hannover 1881



Watermark of the  
Diósgyöri paper mill,  
Hungary, 1782



Jamaica  
pineapple  
1860



India  
elephant head  
1865



Western  
Australia  
black swan  
1854



Tonga turtles  
1897

# Heraldry, coats of arms



Romania 1889

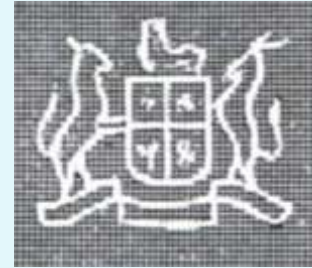

South Africa 1959



1897



Germany 1930



1924



Hungary 1941



1946



Hungary 1947



Brunswick 1853



Poland 1932



China 1894



Cape of Good Hope 1884



Cochin 1911



India 1958



Naples 1858



Vatican City 1931



# Papermakers watermarks found on stamps



Stacey Wise, Rush Mills  
Newfoundland 1862



T H Saunders  
New South Wales 1850



R Turner  
Chafford Mills  
Transvaal  
1878



Alexander Cowan & Sons  
Virgin Islands 1866



Howard & Jones



Afghanistan parcel post 1909

# Papermakers watermarks found on stamps



Pure Linen Wove Bank

William Collins, Sons & Co.  
Rhodesia 1890

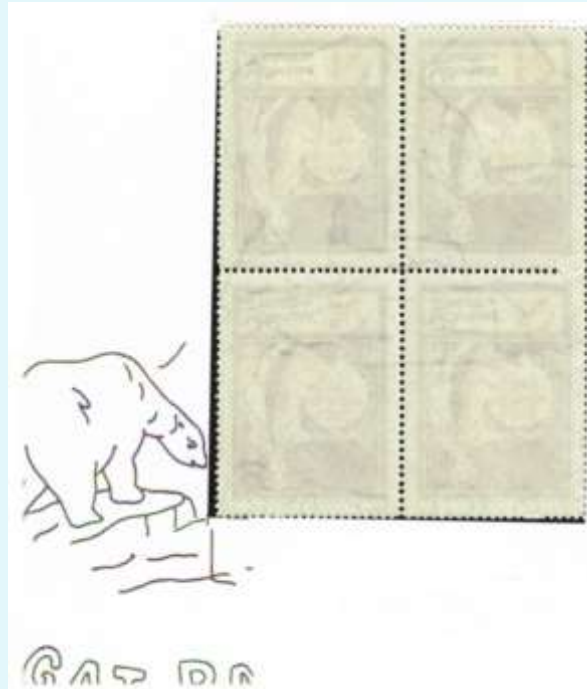

Latvia 1919



# Papermakers watermarks found on postal stationery



Mauritius 1873



Viborg to Helsingfors 08 March 1862



# Chiaroscuro / Light-and-Shade watermarks



© Paper and Watermark Museum, Fabriano

